

Technical Data

KLUDI A-QA
head shower 1 S
200 mm
DN 15

Ref.:
6651005-00

Finishes:
05 chrome

Product description
Manufacturer KLUDI GmbH & Co. KG
Typ: KLUDI A-QA
head shower 1 S DN 15
200 mm
Ref.: 6651005-00
head shower 1 S
1 spray pattern
with cleaning system
Flow rate at 3 bar = 37 l/ min.
connection 1/2"
with ball joint
Ø 200 mm
sieve seal

Product picture



Dimensional drawing

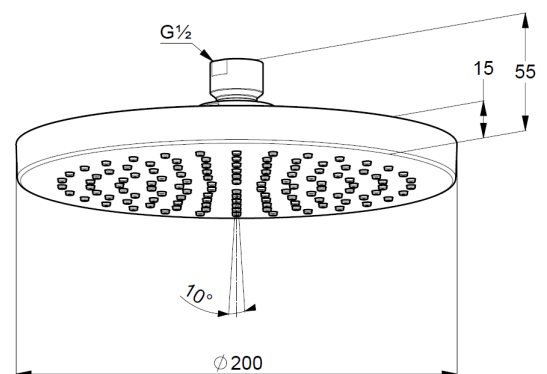

Flow rate diagram

