

## Technical Data

Product: KLUDI A-QA  
Wall shower arm 250 mm,  
DN 15

Article-Nr.: 6654305-00

Surface: 05 chrome

### Product description

manufacturer KLUDI GmbH & Co. KG

Typ: KLUDI A-QA

Wall shower arm 250 mm,

DN 15/ PN 10

Art. Nr. 6654305-00

Wall shower arm

connection 1/2"

for head showers DN 15

escutcheon

Threaded connection 1/2 "

for rigid wall mounting

Product Picture



Dimensional drawing

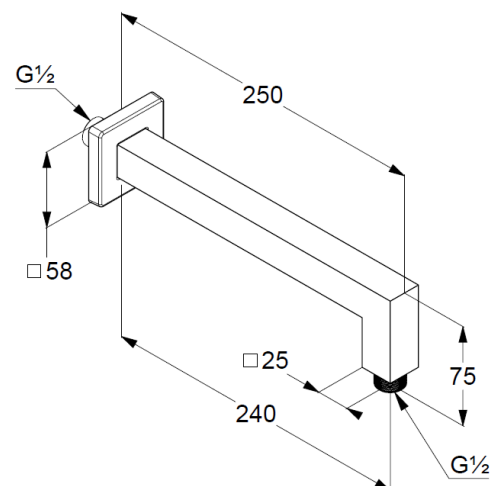

Flow rate diagram